



up+tec®

NO

up+ec tre i en er en universalserie med justerbare pidestaller for bruk med flisheller og terrassebord. Tre artikler (SUPAL, SUPAS og SUPAR) i ett system. De tre kjerneproduktene blir komplementert med tre forskjellige tilbehørprodukter SUPA2 med 2 mm fugebredde, SUPA4 med 4 mm fugebredde og SUPAW (for bjelkelag for montering av terrassebord).



SUPAS
Standard pidestall



SUPAR
Forhøyningsring



SUPAL
Lav pidestall

up+ec® - tre tilbehørprodukter

SUPA2



For 2 mm fugebredde

SUPA4



For 4 mm fugebredde

SUPAW



For trebjelkelag

Fordeler med pidestaller

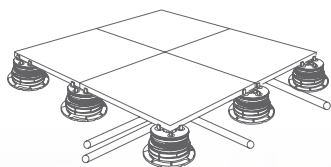

Skjuler rør mm og gir enkel tilgang til disse

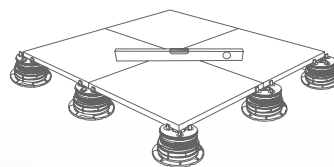

Alltid slett overflate

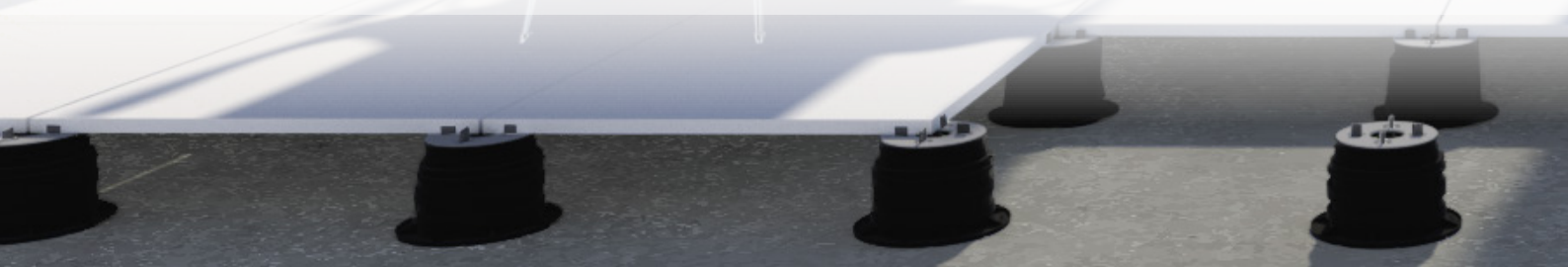

Produkt- og lagerfordeler

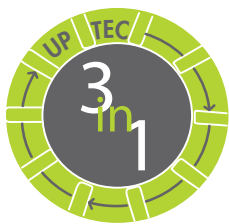

Komplett system med bare 3 artikler



Systemet er i samsvar med EPD-forskrifter (miljødeklarasjon)

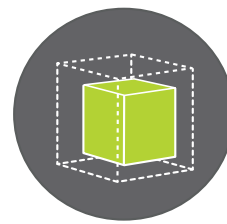

Optimaliserer lagerplass- og lagerinvestering

Fleksibel høyde

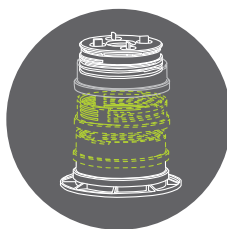

Høyden øker man enkelt ved bruk av SUPAR forhøyningsring



Høydejusterbar pedestall

Fast eller selvnivellerende hode



Selvnivellerende som tar opptil 5 % helling



Man bytter enkelt mellom fast eller selvnivellerende modus

Topplag

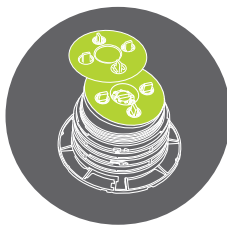

Man bytter enkelt topplag for installasjon med flisheller eller for bjelkelag av tre eller aluminium



Topplag med lyddeppe gumm

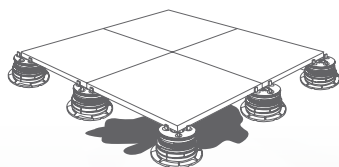

Rask vannavrenning

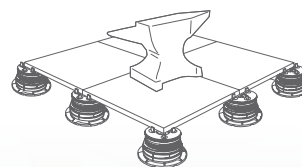

Eksepsjonell bæreevne



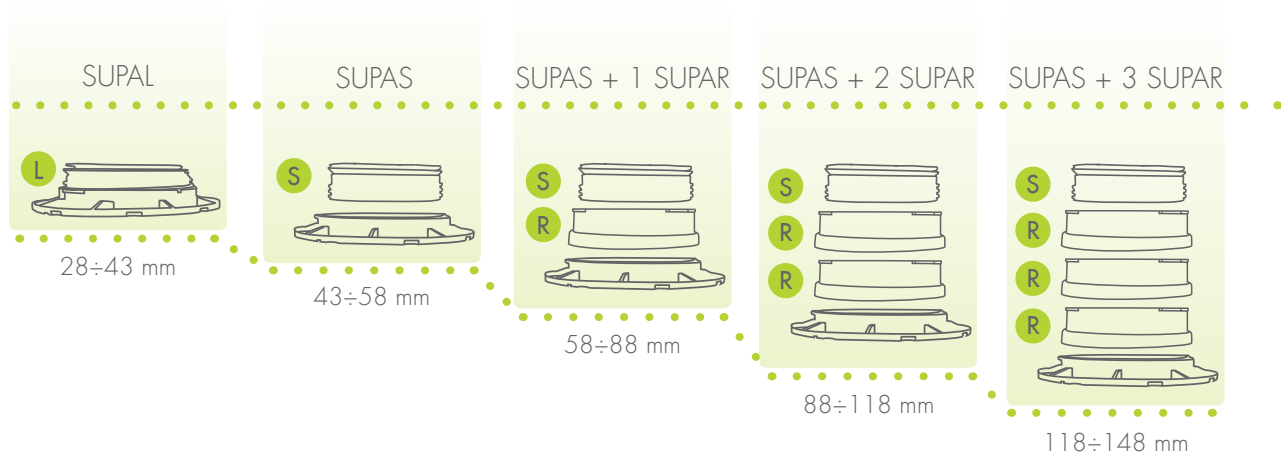

SUPAL (lav pedestall), SUPAS (standard pedestall), SUPAR (forhøyningsring)

up+tec® Montering (Eksempel SUPAS + 1 SUPAR)



up+tec® Montering av topplag



Justeringsverktøy med 3 funksjoner



Gå inn på www.nordictools.no/pidestaller eller www.profilitec.com for mer informasjon om Uptec.



SUPAAN

Aluminium bjelkelag for SUPA4

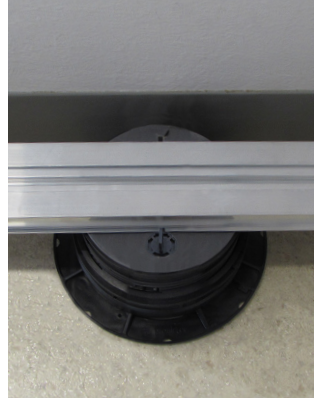
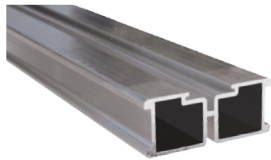

SUPG

Lyddempende gummi for SUPAAN

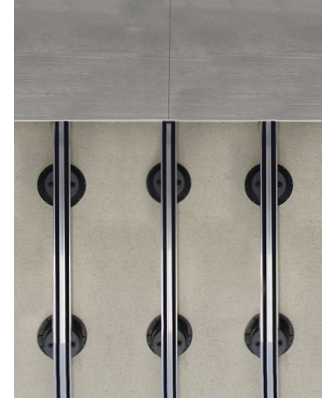
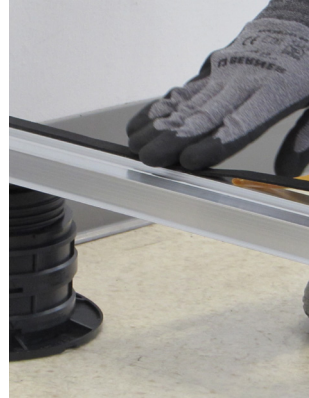
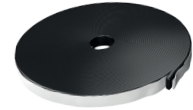

SUPD

Avstandsstykke til fliser som brukes sammen med SUPAAN

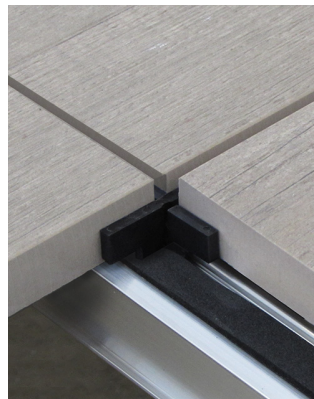

SUPCLIP

Ende- og senterklips til bruk med terrassebord og i kombinasjon med SUPAAN



SUPAJ

For skjøting av SUPAAN

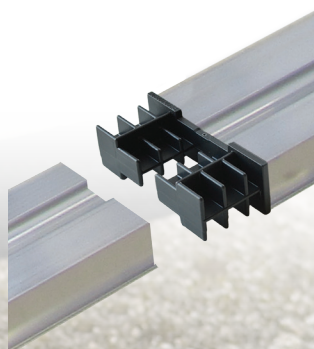
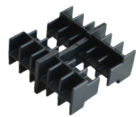

SUPATG

Matte som beskytter underlaget



BSJ

Kantavslutning for 2 cm flisheller. Man lager fronten med flishellen og trer den i sporet på BSJ profilen

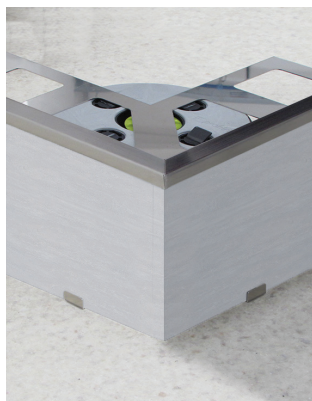

BSR

Kantavslutning for 2 cm flisheller. Leveres i forskjellige høyder

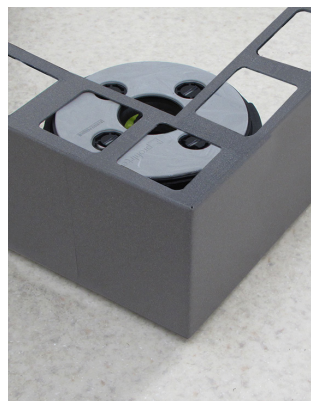

SUPACLPB

For å lage kantavslutning med 2 cm flisheller. Monteres i bunn



SUPACLPT

For å lage kantavslutning med 2 cm flisheller. Monteres på topp



SUPCLPP

For riktig avstand til vegg for flishellene

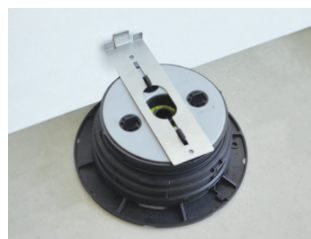

SUPL2 - SUPL3

Utjevningskive
2- og 3 mm

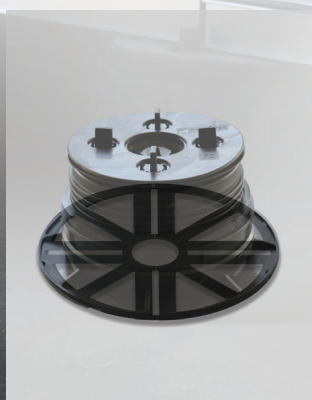

up+tec ground er en serie med pidestaller for flisheller der man ønsker lav byggehøyde. To varianter med justerbare pidestaller som kan justeres i høyder mellom 10 og 15 mm. SUPT med 2 mm fugebredde og SUPT4 med 4 mm fugebredde. Dersom man må bygge høyere enn 15 mm kan man benytte SUPB forhøyningsringer på 5 mm. Maks 3 SUPB, total byggehøyde 30 mm. Høyden kan justeres fra toppen av pidestallen.



SUPT & SUPT4



Høyden kan justeres med 0,5 mm om gangen



Ønsket høyde er godt synlig i mm

SUPB



For å øke høyden på SUPT/SUPT4 med 5 mm

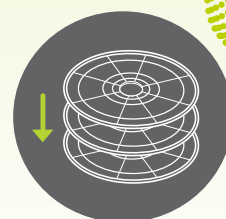

Man kan stable flere i høyden

SUPT



10÷15 mm

SUPT + 1 SUPB



15÷20 mm

SUPT + 2 SUPB



20÷25 mm

SUPT + 3 SUPB



25÷30 mm



positive profile

Profilitec S.p.A.



Via Scotte, 3
36033 Isola Vicentina
(Vicenza) Italy



profilitec@profilitec.com



+39 0444 268311



post@nordictools.no

+47 22 30 40 70



www.profilitec.com

